

premium
plus™

the barrier range

A complete range of sleeves to provide barrier protection in today's modern surgery.



our barrier range

A major area of risk in the spreading of infectious disease is directly related to surfaces in a dental practice.

Our disposable barrier sleeves are designed using an impermeable, soft, pliable plastic that prevents bacteria and infection from passing through the material. Our wide range comes in all shapes and sizes to fit your needs and reduce cross contamination in the practice.

CONTENTS

- Page 5** Syringe/HVE Sleeves | 100B / 100C
Instrument Tray Sleeves | 101 / 102 / 190
- Page 6** Pen/Handpiece Sleeves | 103 / 104S / 104L
Impression Gun Sleeve | 107
- Page 7** X-Ray Sleeves | 108 / 109
Chair/Stool Sleeves | 111 / 112
- Page 8** Headrest Sleeves | 113 / 114
Tube Sleeves | 118 / 119
- Page 9** Curing Light Sleeves | 123SS / 123S / 123L / 123XL
- Page 10** Intra Oral Camera / Curing Light Sleeves 125SS / 125 / 228
- Page 11** Peel-n-Stick Curing Light Guide Sleeve | 128 / 129
Mouse Sleeve | 133S / 133L
Mouth Mirror Sleeve | 140XS
- Page 12** Flowable Composite Syringe Sleeve | 138
T-Style Handle Sleeves | 136 / 106
HVE / Tube Sleeves 135S / 135L
- Page 13** X-Ray Sensor Sleeves | 140XS / 140S / 140M / 140L / 183-1 / 183-2
- Page 14** Bite Block Sleeve | 145
Keyboard Sleeves | 108 / 158S / 158M
- Page 15** PSP Dürr® Type Barrier Envelopes | 188-0 / 188-1 / 188-2 / 188-3 / 188-4
- Page 16** PSP Dürr® Type Barrier Envelopes | 198-0 / 198-1 / 198-2
PSP Digora® (Soredex®) Type Barrier Envelopes | 189-0 / 189-1 / 189-2
PSP Carestream® (Kodak®) Type Barrier Envelopes | 199-0 / 199-1 / 199-2
- Page 17** Protective paper cover 178-0 / 178-1 / 178-2
Barrier Film Rolls | 8008C / 8008B
- Page 18** Order Information

Avoiding cross contamination

There are two effective methods of avoiding cross contamination of surfaces in a dental surgery. Surfaces must either be cleaned and disinfected after each patient or session or barrier sleeves must be applied over all surfaces to prevent the surface from being contaminated in the first instance. When a surface is difficult to clean with a chemical spray or wipe, the application of barrier sleeves could be a more useful solution. Barrier sleeves can limit the number of surfaces that must be cleaned and disinfected between patients, by providing an impermeable barrier against contamination, which can then be quickly and easily disposed. This saves time for dental staff, which is vitally important within a busy schedule.

Barrier sleeves are especially useful in dentistry, in circumstances where:

- surfaces are frequently touched by professionals wearing gloves;
- surfaces are likely to be contaminated by blood or other potentially infectious fluids; and
- there are areas in the surgery that are difficult to clean and disinfect (for example, in between the keys on keyboards, or chair control panels).

Dentists may also find that their advanced medical equipment is unable to be immersed in water to be cleaned or sterilised due to their complex design. Using barrier sleeves is an excellent and effective method to protect this equipment from harsh chemicals and ensure the longevity of the device.

Barrier sleeves offer many advantages within a dental practice:

- reduces the risk of cross contamination in the surgery, protecting staff & patients;
- reducing cleaning and disinfection times between patients;
- increasing the longevity of surfaces due to the reduction of chemical cleaning required;
- preventing contamination in areas that are difficult to clean;
- barriers are single use and can easily be removed and replaced in between patient treatments.

*All information derived from Molinari & Nelson, Protective Environment Surface Barriers in Health Care. The Dental Advisor 2016.





Using barrier sleeves

Before application

Surfaces and equipment should be inspected for damage or contamination. If required, surface should be cleaned and disinfected.

Application

Surfaces and equipment should be covered with barrier sleeves of appropriate design and size. The barrier should fully cover the surface and should be secure enough so that when the surface or equipment is in use, the surface will not be exposed.

After each patient

Wearing gloves, the barrier sleeve should be carefully removed and disposed of using an aseptic technique. Any surfaces which came into contact with a patient should be cleaned and disinfected.

Any surfaces underneath the barrier sleeve which became infected should be cleaned and disinfected. The used gloves should be removed and replaced before new barrier sleeves are applied.

After each session

Clean and disinfect all surfaces according to national government policy. Ensure that appropriate personal protective equipment is worn during the cleaning and disinfection process.

* All information derived from Environmental Asepsis Using Barriers. Kerr TotalCare 2015.

syringe / HVE sleeves

Used for 3 way syringes, saliva ejectors and HVE valves.
Pre-cut opening for easy application. Available in Blue and Clear.
500 pieces / box



100B Blue



100C Clear

instrument tray sleeves

Instruments can be placed directly on top of the sleeve.
500 pieces / box



101 Standard 'B'



102 Mini 'F'



190 Standard ISO

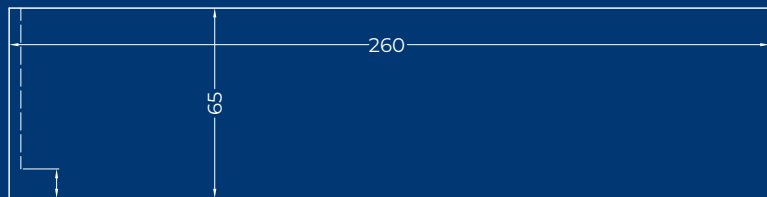

100B Blue 26 cm x 6.5 cm

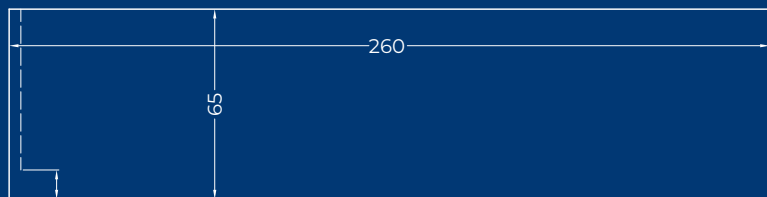

100C Clear 26 cm x 6.5 cm

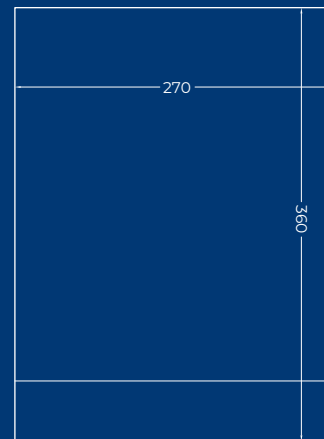

101 Standard 'B' 36 cm x 27 cm

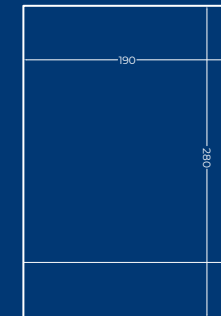

102 Mini 'F' 28 cm x 19 cm

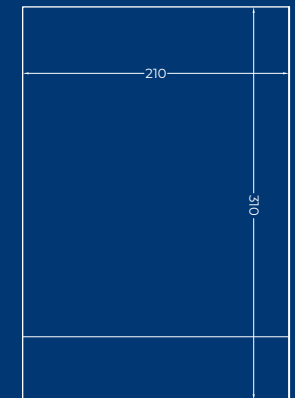

190 Standard ISO 31 cm x 21 cm

pen and handpiece sleeves

Used with pens, handpieces, and ultrasonic scalars.

500 pieces / box



104L Low Speed / Universal Large

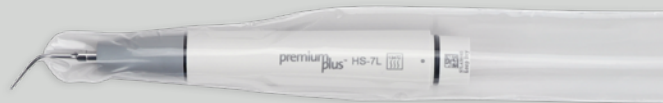

104L Low Speed / Universal Large



104S Low Speed / Universal Slim



103 Pen Shaped Instrument

impression gun sleeves

Sleeve covers cartridge and handle.

Provides protections against cartridge failure or leakage.

500 pieces / box



107 Universal



104L Low Speed / Universal Large 22 cm x 4 cm



104S Low Speed / Universal Slim 22 cm x 3.8 cm



103 Pen Shaped Instrument 22 cm x 2.4 cm

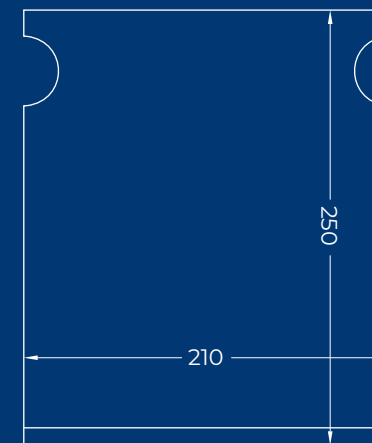

107 Universal 25 cm x 21 cm

x-ray sleeves

For coverage of x-ray units.
250 pieces / box



109 Large

chair/stool sleeves

Eliminates the need for separate headrest covers. Prolongs the life of valuable chairs and stools by avoiding direct contact with harmful disinfectants and aerosols.
125 pieces / box



111 Full Chair

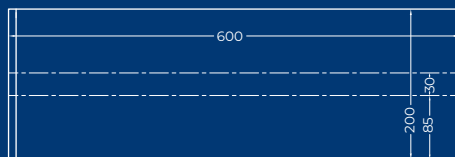

108 Small 60 cm x 20 cm + 17 cm

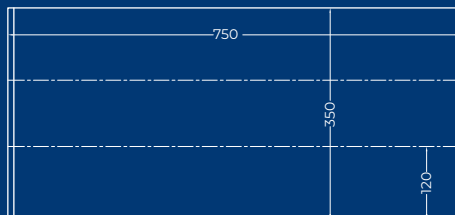

109 Large 75 cm x 35 cm + 24 cm

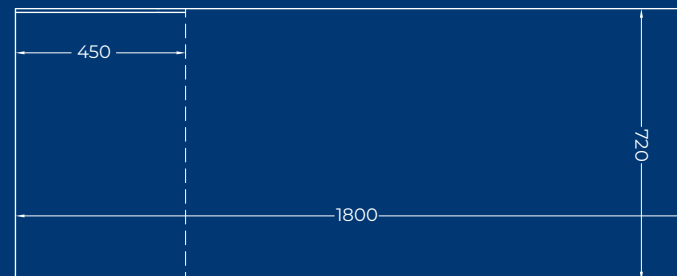

111 Full Chair 180 cm x 72 cm

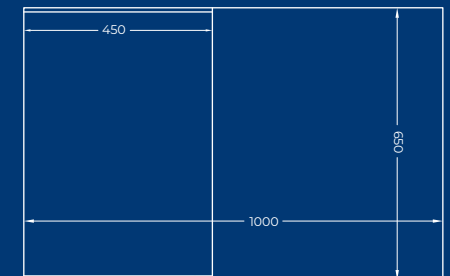

112 Half Chair/Stool 100 cm x 65 cm

headrest sleeves

Creates a clean surface for patients to rest their head while in a chair.
500 pieces / box



114 Large

tubing sleeves

For straight and coiled tubing.
366 metres / roll (1,200 ft)



118 Tubing sleeve for straight tubing

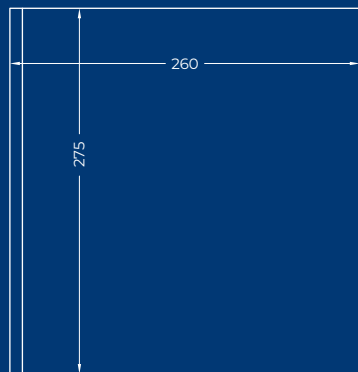

113 Small 27.5 cm x 26 cm

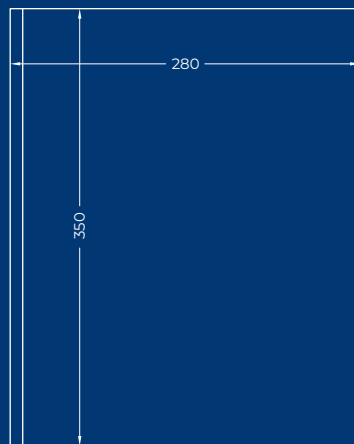

114 Large 35 cm x 28 cm

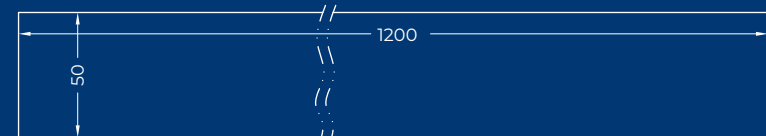

118 Tubing sleeve for straight tubing 2" / 5 cm wide

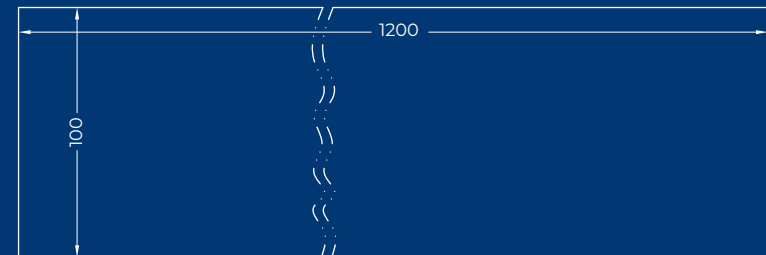

119 Tubing Sleeve for coiled tubing 4" / 10 cm wide

curing light sleeves

A sleeve for every style of curing light.
500 pieces / box

123XL Extra Large



123L Large



123S Small



123SS Small Short



123XL Extra Large 38 cm x 7.2 cm



123L Large 35 cm x 6.5 cm



123S Small 32 cm x 5 cm



123SS Small Short 28 cm x 5 cm



intra oral camera/curing light sleeves

Available in a wide range of sizes to fit most curing lights and intraoral cameras on the market.
500 pieces / box

125SS Short



125 Standard



228 Mini Short



125SS Short 28 cm x 4.9 cm



125 Standard 32 cm x 4.9 cm



228 Mini Short 25 cm x 3.8 cm



peel-n-stick light guide sleeves

The peel-off tab ensures that the light guide can be fully enclosed and sealed off by the barrier sleeve.
200 pieces / box

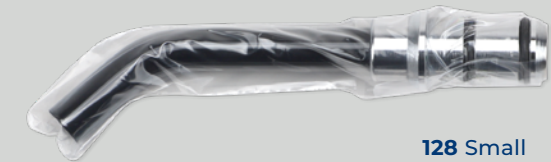

128 Small

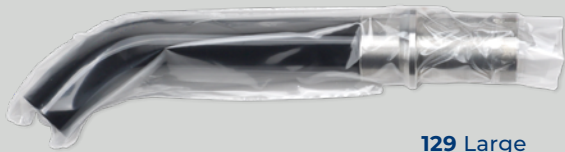

129 Large

pc mouse sleeves

Two sizes available for either corded or cordless optical mice.
500 pieces / box



133S Small



133L Large

mouth mirror sleeves

Made from very supple poly plastic for greater tactile feel.
500 pieces / box



140XS Extra Small

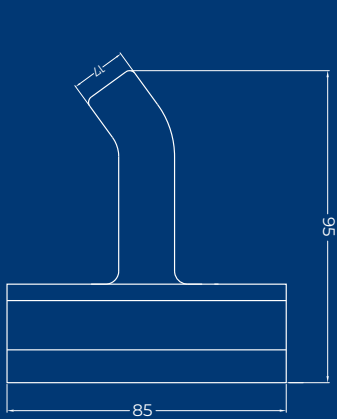

128 Small (fits 7-8 mm light guide)

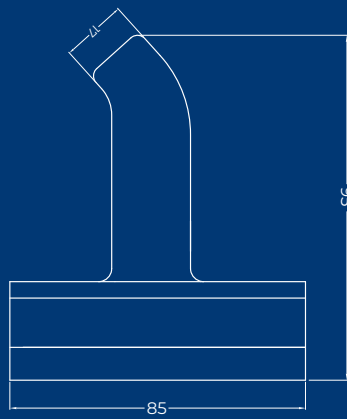

129 Large (fits 9-11 mm light guide)

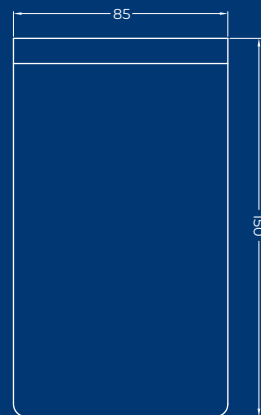

133S Small 15 cm x 8.5 cm

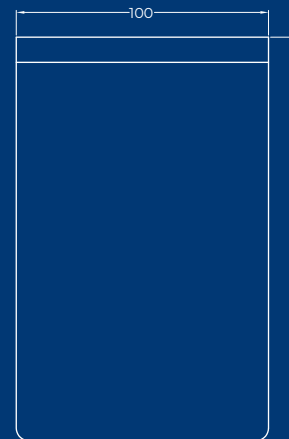

133L Large 16 cm x 10 cm

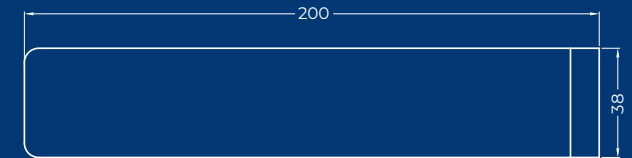

140XS Extra Small 20 cm x 3.8 cm

flowable composite syringe sleeves

Also suitable for other flowable materials which use a syringe and applicator tip, such as etchants, sealants, and cavity liners.
200 pieces / box



138 Universal

t-style light handle sleeves

Universal sizing to fit most t-style handles.
500 pieces / box



106 T-Shape

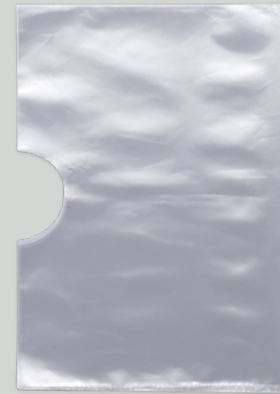

136 Rectangular

HVE suction tube sleeves

Pre-cut for easier application.
500 pieces / box

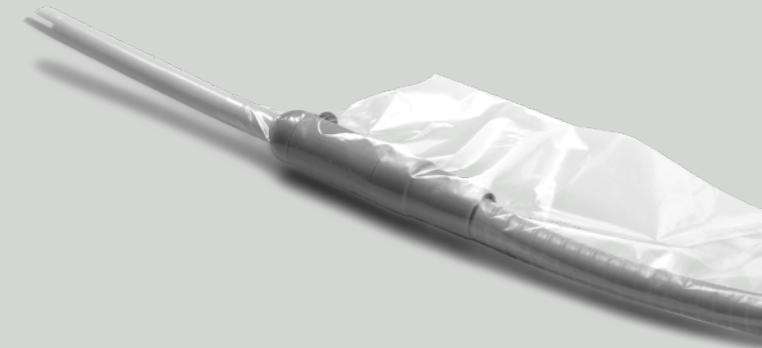

135S Small

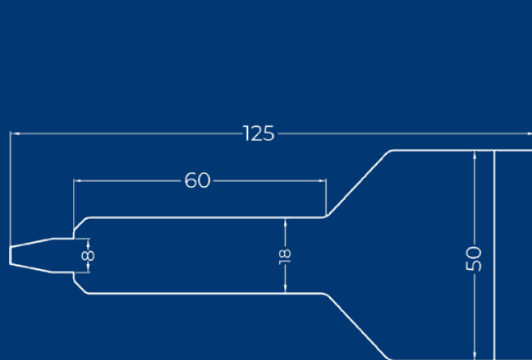

138 Universal 12.5 cm x 5 cm

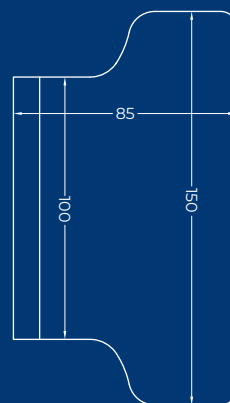

106 T-Shape 15 cm x 8.5 / 10 cm

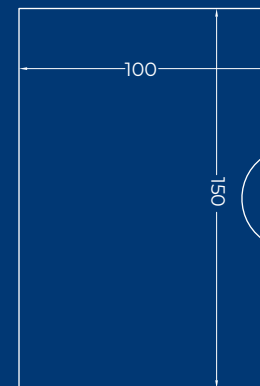

136 Rectangular 15 cm x 10 cm



135S Small (for 11 mm tube) 36 cm x 5.5 cm

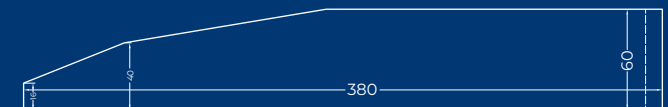

135L Large (for 16 mm tube) 38 cm x 6 cm

x-ray sensor sleeves

Excellent protection for valuable x-ray sensors. Our x-ray sensor sleeves are compatible with almost all x-ray systems.
500 pieces / box



Standard Sensor Sleeve



Two Step Sensor Sleeves

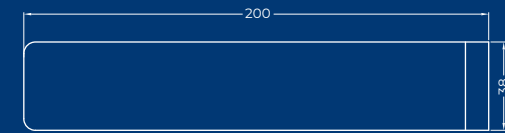

140XS Extra Small 20 cm x 3.8 cm



140S Small 20 cm x 4.2 cm



140M Medium 20 cm x 4.5 cm

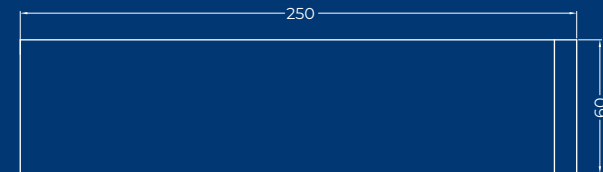

140L Large 25 cm x 6 cm

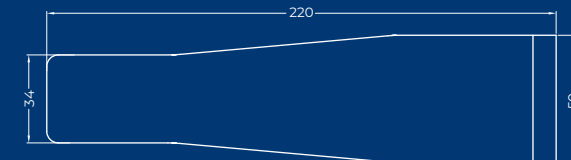

183-1 Size 1 22 cm x 3.4 cm / 5 cm

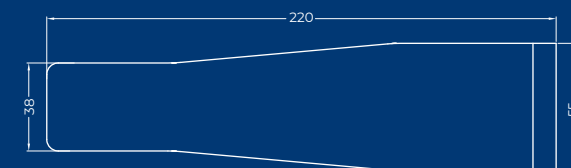

183-2 Size 2 22 cm x 3.8 cm / 5.5 cm

bite block sleeves

Sheaths for 3D bite blocks.
1000 pieces / box



145 Universal

keyboard sleeves

Provides protection from cross contamination without interfering with the movement of the keys.



158S Standard



158M Medium



158L Large



145 Universal 5.5 cm x 2.6 cm

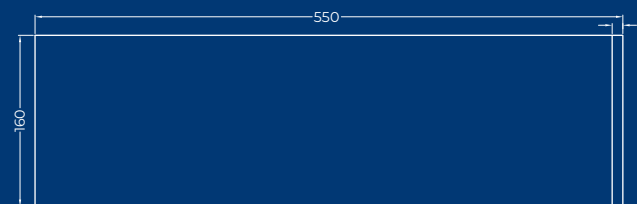

158S Standard 55 cm x 16 cm (500 pieces / box)

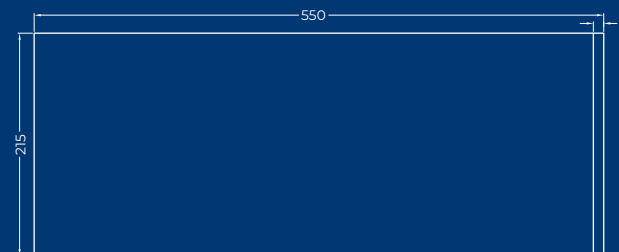

158M Medium 55 cm x 21.5 cm (250 pieces / box)

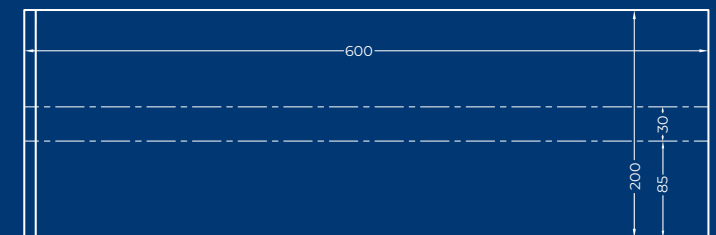

108 Large 60 cm x 20 cm + 17 cm (250 pieces / box)

psp barrier envelopes

Light protection covers designed to fit the most popular phosphor plates.
Made from soft vinyl with rounded corners, the quick tear-off opening makes
them ideal for every day use in a surgery. All measurements are internal dimensions.

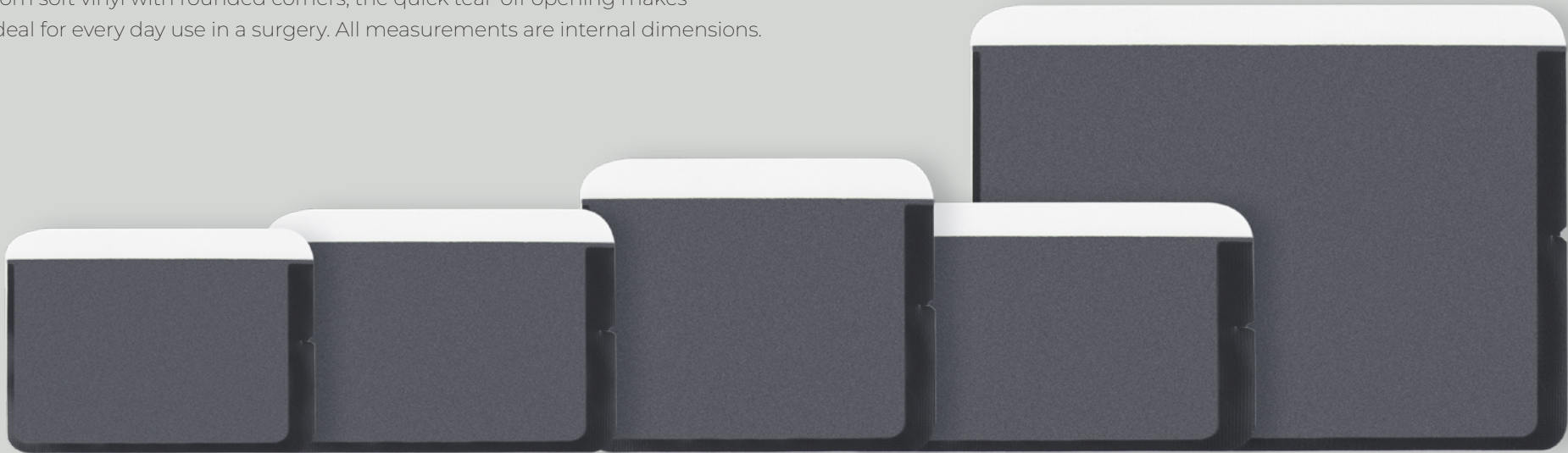

Dürr® Type Mid-Opening Barrier Envelopes

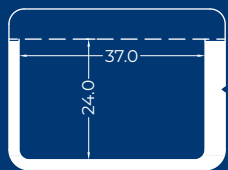

188-0 Size 0
37 mm x 24 mm
(100 pieces / box)

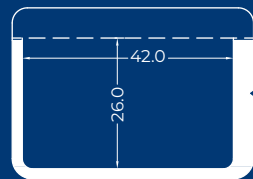

188-1 Size 1
42 mm x 26 mm
(100 pieces / box)

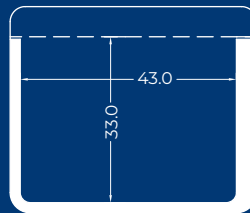

188-2 Size 2
43 mm x 33 mm
(100 pieces / box)

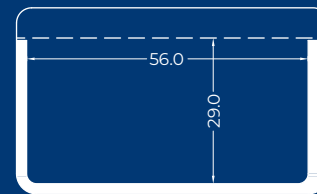

188-3 Size 3
56 mm x 29 mm
(50 pieces / box)

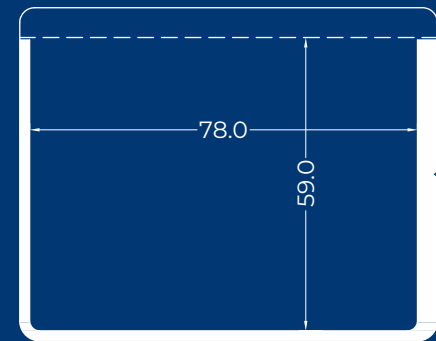

188-4 Size 4
78 mm x 59 mm
(50 pieces / box)



Dürr® Type Top-Opening Barrier Envelopes



Digora® (Soredex® Type) Top-Opening Barrier Envelopes



Kodak® (Carestream® Type) Top-Opening Barrier Envelopes

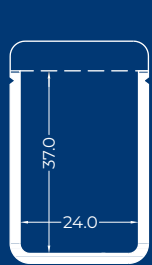

198-0 Size 0
24mm x 37mm
(100 pieces / box)

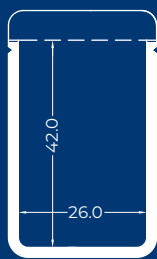

198-1 Size 1
26mm x 42mm
(100 pieces / box)

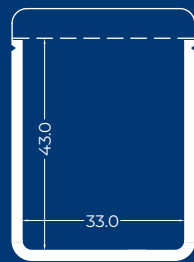

198-2 Size 2
33mm x 43mm
(100 pieces / box)

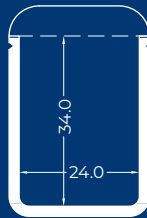

189-0 Size 0
24mm x 34mm
(100 pieces / box)

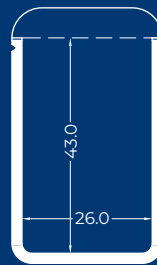

189-1 Size 1
26mm x 43mm
(100 pieces / box)

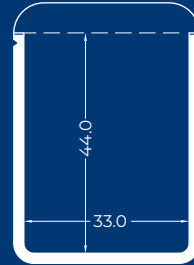

189-2 Size 2
33mm x 44mm
(100 pieces / box)

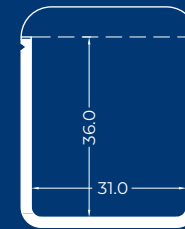

199-0 Size 0
31mm x 36mm
(100 pieces / box)

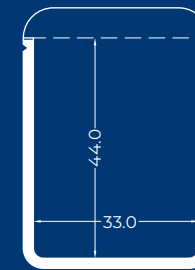

199-1 Size 1
33mm x 44mm
(100 pieces / box)

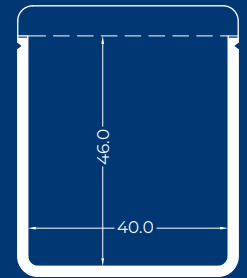

199-2 Size 2
40mm x 46mm
(100 pieces / box)

protective paper cover

Paper covers designed to protect phosphor plates when placed inside a barrier envelope.
100 pieces / box

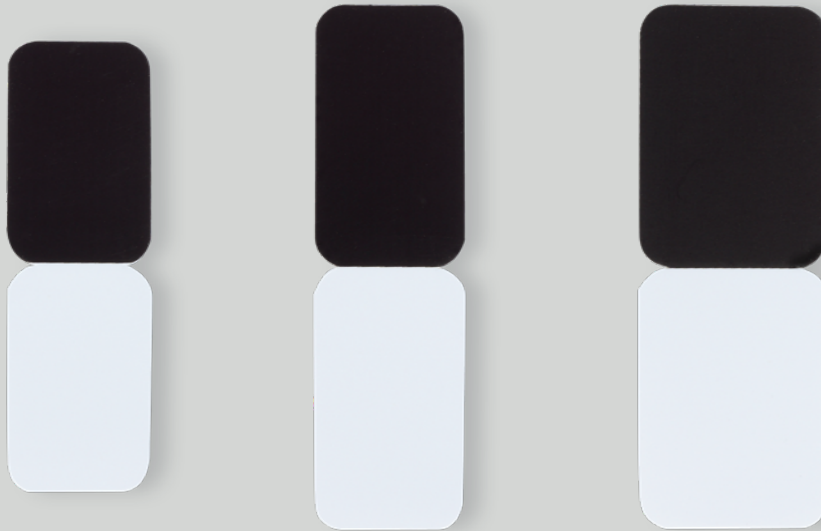

178-0 Size 0

178-1 Size 1

178-2 Size 2

barrier film

With non-adhesive edge for quick removal. Our barrier film leaves no residue when removed.
1200 pieces / roll

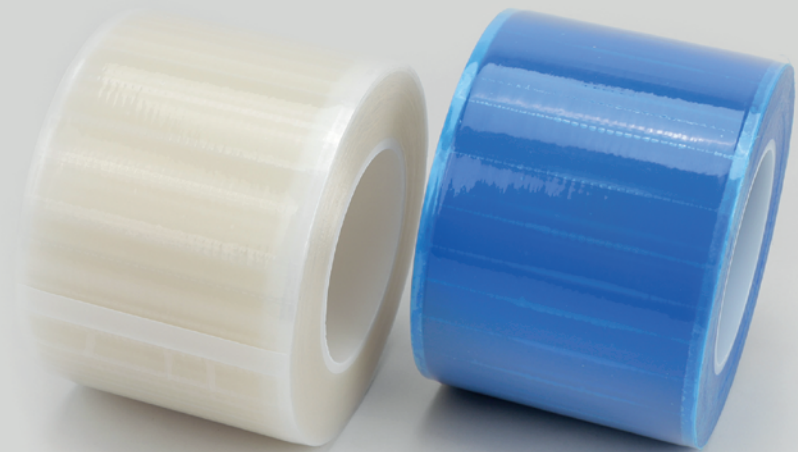

8008C Clear

8008B Blue

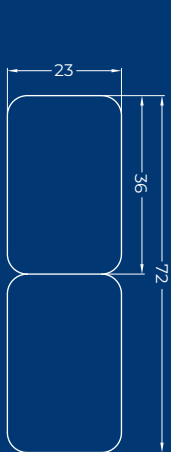

178-0 Size 0 2 x 23 mm x 36 mm

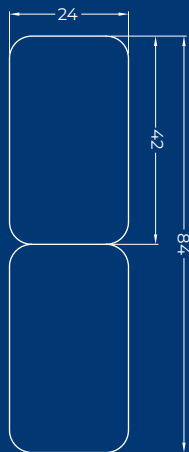

178-1 Size 1 2 x 24 mm x 42 mm

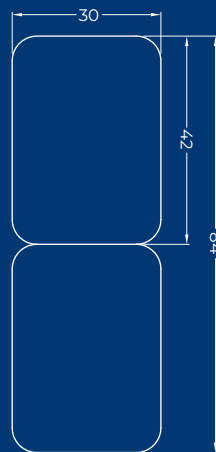

178-2 Size 2 2 x 30 mm x 42 mm

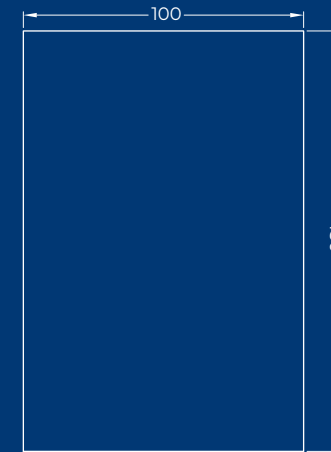

8008C Clear / 8008B Blue 10 cm x 15 cm

Order information

| Order Code | Product Description | Packaging | Carton Qty | Carton Dimensions L x W x H | Carton Weight | Cartons per EU Pallet |
|------------|---|-------------|-----------------|--------------------------------|---------------|--------------------------|
| 100B | 100B Syringe Sleeves 500s Blue | 500 pcs/box | 4x10 boxes/case | 64 x 45 x 23 CM | 17.7 KGS | 20 cartons |
| 100C | 100C Syringe Sleeves 500s Clear | 500 pcs/box | 4x10 boxes/case | 64 x 45 x 23 CM | 17.7 KGS | 20 cartons |
| 101 | 101 Standard Tray Sleeves 500s | 500 pcs/box | 5 boxes/case | 42 x 32 x 23 CM | 11.7 KGS | 35 cartons |
| 102 | 102 Mini Tray Sleeves 500s | 500 pcs/box | 5 boxes/case | 35 x 24 x 23 CM | 6.5 KGS | 63 cartons |
| 103 | 103 High Speed Sleeves 500s | 500 pcs/box | 4x10 boxes/case | 56 x 32 x 25 CM | 6.8 KGS | 21 cartons |
| 104L | 104L Low Speed Sleeves 500s | 500 pcs/box | 4x10 boxes/case | 56 x 32 x 25 CM | 10.1 KGS | 21 cartons |
| 104S | 104S Low Speed Sleeves 500s | 500 pcs/box | 4x10 boxes/case | 56 x 32 x 25 CM | 9.3 KGS | 21 cartons |
| 106 | 106T Light Handle Sleeves 500s | 500 pcs/box | 4x10 boxes/case | 22 x 21 x 24 CM | 2.9 KGS | 128 cartons |
| 107 | 107 Impression Gun Sleeves 500s | 500 pcs/box | 10 boxes/case | 48 x 31 x 23 CM | 12.4 KGS | 35 cartons |
| 108 | 108 Small X-Ray Sleeves 250s | 250 pcs/box | 5 boxes/case | 36 x 24 x 36 CM | 12.1 KGS | 45 cartons |
| 109 | 109 Large X-Ray Sleeves 250s | 250 pcs/box | 3 boxes/case | 43 x 40 x 23 CM | 13.9 KGS | 32 cartons |
| 111 | 111 Full Chair Sleeves 125s | 125 pcs/box | 3 boxes/case | 43 x 36 x 29 CM | 13.9 KGS | 24 cartons |
| 112 | 112 Half Chair/Stool Sleeves 125s | 125 pcs/box | 3 boxes/case | 41 x 39 x 23 CM | 7.7 KGS | 32 cartons |
| 113 | 113 Headrest Sleeves 500s Small | 500 pcs/box | 10 boxes/case | 61 x 35 x 23 CM | 14.2 KGS | 24 cartons |
| 114 | 114 Headrest Sleeves 500s Large | 500 pcs/box | 10 boxes/case | 61 x 41 x 22 CM | 20.4 KGS | 36 cartons |
| 118 | 118 Tube Sleeve 1200ft roll 5cm | 366 m/roll | 4 rolls/case | 40 x 23 x 16 CM | 3.6 KGS | 120 cartons |
| 119 | 119 Tube Sleeve 1200ft roll 10cm | 366 m/roll | 4 rolls/case | 36 x 20 x 26 CM | 6.9 KGS | 84 cartons |
| 123L | 123L Pen Type Curing Light Sleeves 500s Large C01-S/D | 500 pcs/box | 4x10 boxes/case | 85 x 44 x 24 CM | 20.1 KGS | 11 cartons |
| 123S | 123S Pen Type Curing Light Sleeves 500s Small C01-C | 500 pcs/box | 4x10 boxes/case | 70 x 40 x 25 CM | 14.6 KGS | 21 cartons |
| 123SS | 123SS Pen Type Curing Light Sleeves 500s Small Short C01-C | 500 pcs/box | 4x10 boxes/case | 68 x 36 x 25 CM | 12.9 KGS | 21 cartons |
| 123XL | 123XL Pen Type Curing Sleeves 500s Extra Large | 500 pcs/box | 2x10 boxes/case | 44 x 43 x 19 CM | 11.8 KGS | 32 cartons |
| 125 | 125 Intraoral Camera/RA Curing Light Sleeves 500s C02-C/S/D | 500 pcs/box | 4x10 boxes/case | 70 x 40 x 25 CM | 15.2 KGS | 21 cartons |
| 125SS | 125SS Intraoral Camera/RA Curing Light Sleeves 500s Small Short C02-C/D | 500 pcs/box | 4x10 boxes/case | 68 x 37 x 25 CM | 13.4 KGS | 21 cartons |
| 128 | 128 Light Guide Sleeves 200s Small | 200 pcs/box | 4x50 boxes/case | 48 x 45 x 35 CM | 11.7 KGS | 16 cartons |
| 129 | 129 Light Guide Sleeves 200s Large | 200 pcs/box | 4x50 boxes/case | 48 x 45 x 35 CM | 11.7 KGS | 16 cartons |
| 133L | 133L PC Mouse Sleeves 500s Large | 500 pcs/box | 4x10 boxes/case | 50 x 42 x 25 CM | 13.3 KGS | 32 cartons |
| 133S | 133S PC Mouse Sleeves 500s Large | 500 pcs/box | 4x10 boxes/case | 50 x 42 x 25 CM | 12.3 KGS | 32 cartons |
| 135L | 135L HVE Suction Tube Sleeves 500s Large | 500 pcs/box | 20 boxes/case | 44 x 42 x 20 CM | 10.3 KGS | 40 cartons |
| 135S | 135S HVE Suction Tube Sleeves 500s Small | 500 pcs/box | 20 boxes/case | 41 x 41 x 20 CM | 8.9 KGS | 40 cartons |

| | | | | | | |
|-------|---|------------------|-----------------|------------------|----------|-------------|
| 136T | 136 T Handle Sleeves 500s | 500 pcs/box | 4x10 boxes/case | 25 x 21 x 24 CM | 3.9 KGS | 128 cartons |
| 138 | 138 Composite Syringe Sleeves 200s | 200 pcs/box | 100 boxes/case | 56 x 29 x 15 CM | 4.6 KGS | 78 cartons |
| 140L | 140L X-Ray Sensor Sleeves 500s Large | 500 pcs/box | 4x10 boxes/case | 63 x 42 x 25 CM | 15.1 KGS | 24 cartons |
| 140M | 140M X-Ray Sensor Sleeves 500s Medium | 500 pcs/box | 4x10 boxes/case | 52 x 32 x 25 CM | 10.9 KGS | 32 cartons |
| 140S | 140S X-Ray Sensor Sleeves 500s Small | 500 pcs/box | 4x10 boxes/case | 52 x 32 x 26 CM | 10.1 KGS | 28 cartons |
| 140XS | 40XS X-Ray Sensor Sleeves 500s Extra Small | 500 pcs/box | 4x10 boxes/case | 52 x 33 x 25 CM | 9.3 KGS | 32 cartons |
| 145 | 145 Bite Block Sleeves 1000s | 1000 pcs/box | 40 boxes/case | 43 x 28 x 16 CM | 4 KGS | 84 cartons |
| 158 | 158 Standard Keyboard Sleeves 500s Small | 500 pcs/box | 10 boxes/case | 39 x 36 x 35 CM | 18.2 KGS | 30 cartons |
| 158M | 158M Standard Keyboard Sleeves 250s Medium | 250 pcs/box | 10 boxes/case | 50 x 38 x 23 CM | 13.8 KGS | 32 cartons |
| 1831 | 183-1 Two Step X-Ray Sensor Sleeves 500s | 500 pcs/box | 4x10 boxes/case | 56 x 37 x 25 CM | 11.8 KGS | 32 cartons |
| 1832 | 183-2 Two Step X-Ray Sensor Sleeves 500s | 500 pcs/box | 4x10 boxes/case | 56 x 237 x 25 CM | 12 KGS | 32 cartons |
| 1880 | 188-0 Barrier Envelopes 100s No. 0 | 100 pcs/box | 100 boxes/case | 24 x 23 x 17 CM | 2.5 KGS | 132 cartons |
| 1881 | 188-1 Barrier Envelopes 100s No. 1 | 100 pcs/box | 100 boxes/case | 27 x 22 x 18 CM | 3.8 KGS | 132 cartons |
| 1882 | 188-2 Barrier Envelopes 100s No. 2 | 100 pcs/box | 100 boxes/case | 28 x 28 x 22 CM | 4.9 KGS | 64 cartons |
| 1883 | 188-3 Barrier Envelopes 50s No. 3 | 50 pcs/box | 100 boxes/case | 33 x 21 x 13 CM | 2.8 KGS | 117 cartons |
| 1884 | 188-4 Barrier Envelopes 50s No. 4 | 50 pcs/box | 100 boxes/case | 48 x 32 x 18 CM | 6.4 KGS | 50 cartons |
| 1890 | 189-0 Barrier Envelopes 100's No.0 | 100 pcs/box | 100 boxes/case | 25 x 24 x 16 CM | 3.1 KGS | 132 cartons |
| 1891 | 189-1 Barrier Envelopes 100's No.1 | 100 pcs/box | 100 boxes/case | 28 x 24 x 17 CM | 3.4 KGS | 120 cartons |
| 1892 | 189-2 Barrier Envelopes 100's No.2 | 100 pcs/box | 100 boxes/case | 18 x 14 x 20 CM | 4 KGS | 108 cartons |
| 190 | 190 ISO Tray Sleeves 500s | 500 pcs/box | 5 boxes/case | 37 x 26 x 24 CM | 7.1 KGS | 56 cartons |
| 1980 | 198-0 Barrier Envelopes 100s No.0 | 100 pcs/box | 100 boxes/case | 22 x 21 x 17 CM | 2.8 KGS | 180 cartons |
| 1981 | 198-1 Barrier Envelopes 100s No.1 | 100 pcs/box | 100 boxes/case | 28 x 23 x 15 CM | 3.2 KGS | 144 cartons |
| 1982 | 198-2 Barrier Envelopes 100s No.2 | 100 pcs/box | 100 boxes/case | 28 x 23 x 18 CM | 3.9 KGS | 120 cartons |
| 1990 | 199-0 Barrier Envelopes 100's No.0 | 100 pcs/box | 100 boxes/case | 25 x 24 x 18 CM | 3.6 KGS | 132 cartons |
| 1991 | 199-1 Barrier Envelopes 100's No.1 | 100 pcs/box | 100 boxes/case | 29 x 24 x 19 CM | 3.9 KGS | 120 cartons |
| 1992 | 199-2 Barrier Envelopes 100's No.2 | 100 pcs/box | 100 boxes/case | 30 x 24 x 22 CM | 4.9 KGS | 108 cartons |
| 228 | 228 Pen Type Curing Light Sleeves 500s C01/2M | 500 pcs/box | 4x10 boxes/case | 56 x 32 x 25 CM | 10.7 KGS | 32 cartons |
| 1780 | 178-0 Protective Covers 100s No.0 | 100 pcs/box | 100 boxes/case | 27 x 23 x 15 CM | 3.8 KGS | 156 cartons |
| 1781 | 178-1 Protective Covers 100s No.1 | 100 pcs/box | 100 boxes/case | 27 x 20 x 19 CM | 4.7 KGS | 160 cartons |
| 1782 | 178-2 Protective Covers 100s No.2 | 100 pcs/box | 100 boxes/case | 28 x 19 x 19 CM | 4.9 KGS | 120 cartons |
| 8008B | 8008 Barrier Film 10cm x 15cm Blue | 1200 sheets/roll | 10 rolls/case | 58 x 31 x 17 CM | 11.1 KGS | 44 cartons |
| 8008C | 8008 Barrier Film 10cm x 15cm Clear | 1200 sheets/roll | 10 rolls/case | 58 x 31 x 17 CM | 11.1 KGS | 44 cartons |

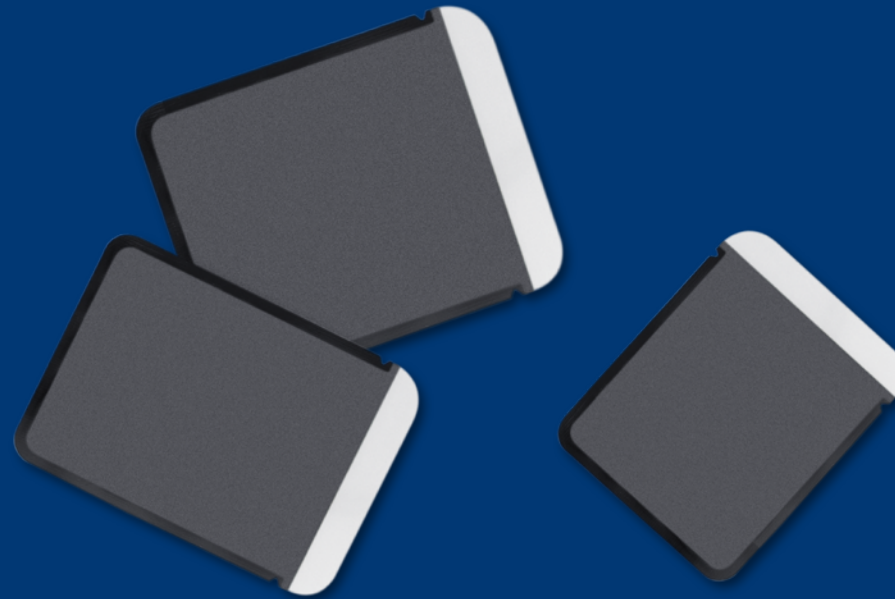

www.premiumpluspoland.com

European Office

Premium Plus Poland sp. z o.o.
ul. Bukowska 27
62-081
Wysogotowo
Poland

+48 61 880 1094
info@premiumpluspl.com
www.premiumpluspoland.com

UK Office

Premium Plus UK Ltd.
Unit 2, Knighton Heath Ind. Estate,
Bournemouth,
Dorset BH11 8NE
UK

+44 1202 611011
info@premiumplusuk.com
www.premiumplusuk.com

Corporate Head Office

Premium Plus International Ltd.
Flat 1001, Yuen Long Trading Centre,
No.33 Wang Yip Street West,
Yuen Long
Hong Kong

+852 2761 3211
mailbox@premiumplushk.com
www.premiumplushk.com

Manufacturing Facility

Premium Plus Dongguan Limited
Flat 101, No.122 Tianqiao Road
Tutang, Changping, Dongguan,
Guandong
China

+86 769 83756768
info@premiumpluschina.com
www.premiumpluschina.com

USA Office

Premium Plus Dental Supplies Inc.
155 Liberty Avenue
Brooklyn
New York 11212
United States of America

+1 718 366 8686
info@premiumplusdentalusa.com
www.premiumplususa.com

Japan Office

Premium Plus Japan Co. Ltd.
5th Floor, 1-1-31, Nishimidorigaoka,
Toyonakashi
Osaka 560-0005
Japan

+81 6 6845 0066
info@premiumplus.jp
www.premiumplus.jp